



**UV BOX**  
**Germicidal Enclosure**  
**INSTRUCTIONS FOR USE**

# Indications for Use

## Intended use

The UV BOX Germicidal Enclosure disinfection unit is intended to allow authorized trained personnel the ability to disinfect a non-critical device (NCD) or mobile devices such as Tablets, and Phones on demand. The UV BOX Germicidal Enclosure is not intended to be used to pre-clean or decontaminate critical or semi-critical medical devices prior to terminal sterilization or high level disinfection.



**WARNING:** Do not place vessels containing liquid of any kind, or bottles containing medications of any kind, into the UV BOX Germicidal Enclosure.

## Device Indications for Use Statement

The UV BOX Germicidal Enclosure's disinfection function is achieved through the application of high intensity germicidal UVC light applied at a known intensity and for a known duration. The intention is to allow the user to position their non-critical medical devices and small mobile devices inside the UV BOX Germicidal Enclosure for disinfection process. Operation of the system is to take place outside of sterile fields and by personnel performing their duties outside of sterile fields. Typical operating personnel are trained professionals, including but not limited to physicians, nurses, technicians and environmental services staff.

## System User Safety Controls

The UV BOX Germicidal Enclosure has multiple safety controls and mechanisms to insure that users are safe and protected during the UVC disinfection operations.



**WARNING:** Do not intentionally bypass any of the safety precautions built into the device. Failure to comply may result in exposing skin to UVC. Prolonged skin exposure may generate redness and an uncomfortable sunburn sensation.

The following safety controls are built into the UV BOX Germicidal Enclosure: The outer casing has an easily accessible power switch. The door in the front of the UV BOX Germicidal Enclosure has a locking knob that when turned counter clockwise to “Open” will immediately turn off the power to the UV light source. In addition, the UV BOX Germicidal Enclosure can be unplugged to disconnect power and light source.

## **Procedures for Disposal of UVC Bulbs**

UV BOX technology uses bulbs with lower mercury content than typical overhead lighting, and cleaning should follow the practices required by your facility and in accord with applicable regulations. As a guideline, if bulbs are broken, ventilate the area where the breakage occurred. Clean up with mercury vacuum cleaner or other suitable means that avoid dust and mercury vapor generation. Take usual precautions for collection of broken glass. Clean up requires special care due to mercury droplet proliferation. Place materials in closed containers to avoid generating dust. It is the responsibility of the generator to ensure proper classification of waste products. To that end, TCLP tests should be conducted on all waste products to determine the ultimate disposition in accordance with all applicable federal, state and local regulations.

## **Special Handling Information for Broken UVC Bulbs**

**Ventilation:** Use adequate general and local exhaust ventilation to maintain exposure levels below the permissible exposure limit (PEL) or threshold limit value (TLV) limits. If such ventilation is unavailable, use respirators as specified below.

**Respiratory Protection:** Use appropriate NIOSH (National Institute for Occupational Safety and Health) approved respirator if airborne dust concentrations exceed the PEL or TVL limits. All appropriate requirements set forth in 29 CFR 1910134 should be met.

**Eye Protection:** OSHA (Occupational Safety and Health Administration) specified safety glasses, goggles or face shield are recommended if bulbs are broken.

**Hygienic Practices:** After handling broken bulbs, wash thoroughly before eating, smoking or using the toilet facilities.

In the event that a UV Box bulb arrives in a broken condition and is still inside the bag, keep the bag sealed and discard the UV Box bulb in accord with the practices required by your facility and with applicable regulations. Contact your carrier for procedures to file a damaged goods claim.

Check your local or regional specific occupational safety standards for any additional procedures or precautions required for the handling of broken UVC bulbs.

# Bulb and Rod Replacement

Note: Use of any bulb other than that expressly and directly purchased from an Advanced Ultra-Violet Systems fully authorized source will cause failure in the disinfection cycle. This may result in electrical failure that is not covered under warranty and will cause premature device failure. Use of any bulbs other than those provided by the manufacturer is prohibited. In order to replace a bulb or a crystal rod, follow these instructions:

## Replacing a Crystal Rod

- First remove the access panel on the left side of the UV BOX. (see figure A)
- Carefully slide out the broken Crystal Rod. Be cautious of sharp edges.
- Discard broken rod, making certain to remove all fragments from the inside of the UV BOX Germicidal Enclosure. See: **Cleaning the UV BOX Germicidal Enclosure.**
- Gently insert the new Crystal Rod in the vacant slot and replace the access panel.

## Replacing a UVC Bulb

- First remove the access panel on the left side of the UV BOX. (see figure A)
- Carefully slide out and set aside the Crystal Rods to gain access to the UVC Bulb enclosure. Remove the affected UVC Bulbs. See: **Procedures for Disposal of Bulbs and Special Handling Information for Broken Bulbs.**
- Replace inoperative UVC bulb(s) with new UV BOX Approved UVC Bulb(s) only.
- Gently reinsert the Crystal Rods into their slots and replace the access panel.

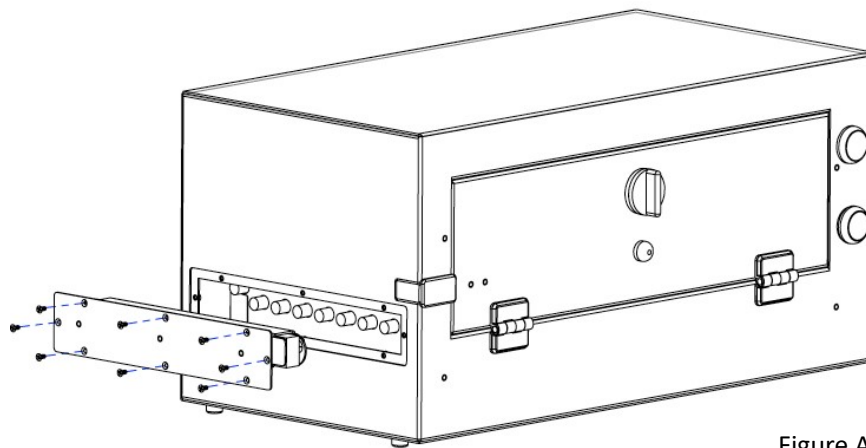

Figure A

# Cleaning the UV BOX Germicidal Enclosure



**PRECAUTION:** Avoid spilling fluids on any part of the UV BOX Germicidal Enclosure.



**PRECAUTION:** If spills do occur, immediately disconnect the UV BOX Germicidal Enclosure from the power source and contact technical support for guidance in cleaning the device. 866-918-8546.



**WARNING:** Always power off the system before cleaning. An electrical shock could occur if the device is powered on and liquid is spilled into it.

To clean the **OUTSIDE** of the UV BOX Germicidal Enclosure without physical or cosmetic degradation, use a clean, lint-free cloth moistened with one of the following:







- Phenolic Disinfectant Cleaner (meets VII.d.4 of AORN recommendation)
- 1 part household bleach and 5 parts water (meets VII.e.2 of AORN recommendation)
- A-456-N Disinfectant
- Virex 256 Disinfectant
- Isopropyl Alcohol, 70% solution

The following pre-moistened disposable cloths may also be used for cleaning the **OUTSIDE** of the Device.

- PDI Sani-Cloth HB
- PDI Sani-Cloth PLUS
- PDI Super Sani-Cloth

To clean the **INSIDE** of the UV BOX Germicidal Enclosure without physical degradation, use only a clean lint-free cloth moistened with a mixture of alcohol and water (1:1). Residues of alcohol based cleaning products should be wiped away with a clean lint-free cloth moistened with water. Allow the device to dry completely before operating again.

## Cleaning Precautions

-  PRECAUTION: Apply cleaning agents to clean lint-free cloth first and then clean the device. Liquid sprayed or applied directly to the device could possibly leak inside and cause damage.
-  PRECAUTION: Allow the device to completely dry before operating again.
-  PRECAUTION: Never use abrasive materials.
-  PRECAUTION: Never use any disinfecting agents that corrode.
-  PRECAUTION: Always dilute cleaning agents according to manufacturer's instructions.
-  PRECAUTION: Do not allow the cleaning agent to remain on the device surface. Wipe off immediately with a lint-free cloth moistened with water. Failure to do so may result in discoloration of the surface.
-  WARNING: Advanced Ultra-Violet Systems makes no claims regarding the efficacy of the listed chemicals or methods as a means of controlling infection. Consult your facility's infection control officer or epidemiologist.

## Specifications and Warranty Information

The UV BOX Germicidal Enclosure Device is warranted for one (1) year from the date of delivery to the customer's facility. All parts and labor are covered under this period, excluding damage due to abuse by the user.

UV BOX Germicidal Enclosure Specifications	
Overall Dimensions	10" H x 10" D x 20" W
Enclosure Dimensions	3.5" H x 8" D x 15.5" W
Weight	10 lbs.
Power	110V, AC
Bulb Life	7 Years with Heavy Use